

**Features and Benefits**

- Magnet actuated for a variety of proximity sensing applications
- Non-contact, solid state device
- Reads speeds 0 to 100 kHz
- Digital output signal
- 4 to 24 VDC operation range
- Current sinking output
- 20ma continuous operation
- Reverse polarity protection
- Temperature compensated
- Operates from -40°C to 125°C
- Rugged thermoplastic housing

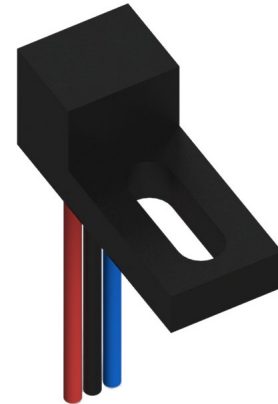

Sensor

Wire color order varies with part configuration

**Electrical Circuit**

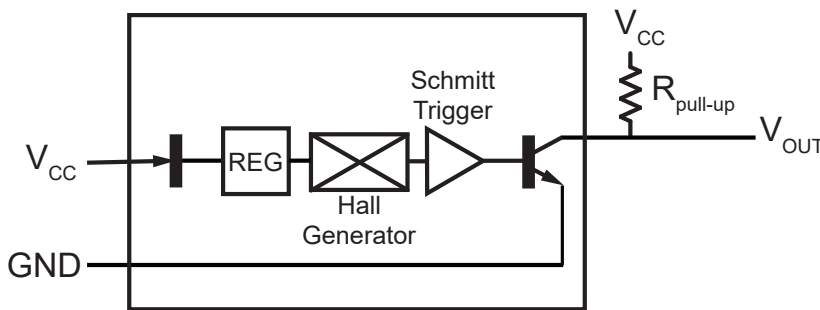

Output channels require customer supplied pull-up resistors unless internal pull-up option is selected. See Table 1.1 for recommended resistor values.

Note: A pull-up resistor is required on the open collector output to establish a quiescent voltage level. The pull-up resistor also provides faster rise times and improves noise immunity. Contact the factory for application assistance.

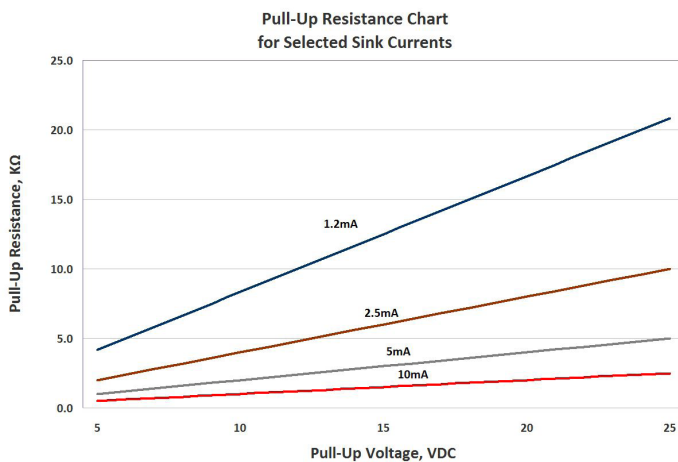

**Table 1.1**

Recommended Pull-Up Resistor Values			
Current, I <sub>sink</sub>	Supply Voltage		
	5	12	24
1.2 mA	4.3K	10.0K	20.0K
2.5 mA	2.0K	4.7K	10.0K
5 mA	1.0K	2.4K	4.7K
10 mA	510Ω	1.2K	2.4K

I<sub>sink</sub> is application dependent. It is recommended to use the lowest possible sink current when selecting a pull-up resistor.

Theoretical Pull-Up Resistor Calculation:  $R_{pullup} = \frac{V_{supply}}{I_{sink}}$

Resistance values based on closest standard 5% resistor values

Absolute Maximum I<sub>sink</sub> = 20mA

4.7 K pull-up is available as a standard option. If an alternative pull-up value is preferred, contact sales@phoenixamerica.com.

**Physical Outline**

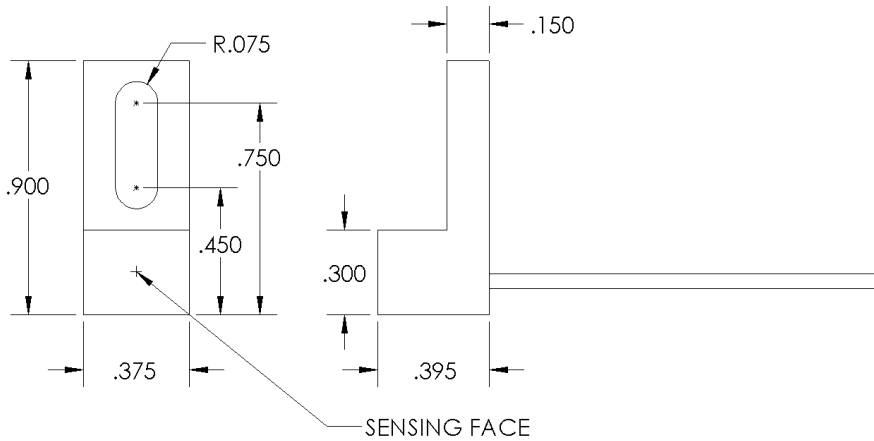

**Output Waveforms**

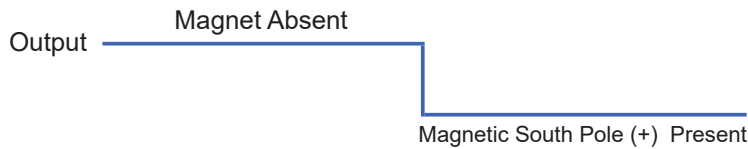

**Magnetic Characteristics (VCC = 4.5 to 24 VDC @ 25°C)**

Table 2.1

Characteristic	Symbol	Limits			Units
		Min.	Typ.	Max.	
Operating Point	B <sub>OP</sub>	140	150	160	Gauss
Release Point	B <sub>RP</sub>	40	50	110	Gauss
Hysteresis	B <sub>HYS</sub>	30	100	120	Gauss
Maximum Field Exposure	B <sub>MAX</sub>	-800		800	Gauss
Active Element Depth	D <sub>P</sub>			0.044	Inch

**Electrical Characteristics (T = -40 to 125°C)**

Table 2.2

Characteristic	Symbol	Test Condition	Limits			Units
			Min.	Typ.	Max.	
Supply Voltage	V <sub>CC</sub>	Operating	4.5		24	VDC
Supply Current	I <sub>S</sub>	V <sub>CC</sub> = 4.5V; Output Open		4.7	8.0	mA
Output Current	I <sub>OUT</sub>	V <sub>CC</sub> = 4.5V; Output Open			20	mA
Output Saturation Voltage	V <sub>OUT(SAT)</sub>	B > B <sub>OP</sub> ; I <sub>OUT</sub> = 20ma		150	400	mV
Output Leakage Current	I <sub>OFF</sub>	B < B <sub>RP</sub> ; V <sub>OUT</sub> = 24V		4.7	8.0	µA
Rise/Fall Time	t <sub>r</sub> / t <sub>f</sub>	R <sub>L</sub> = 1.2k; C <sub>L</sub> < 33pF			1	µs

**Wiring**

FLYING LEADS

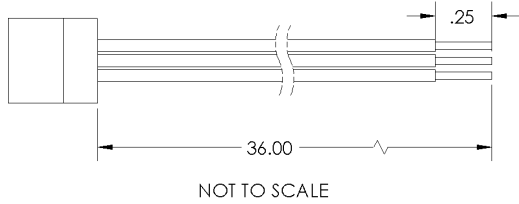

- 24 AWG
- PVC Insulation

**Table 3.1**

Standard Wiring Color Code	
	Flying Leads
<b>Vcc</b>	Red
<b>Gnd</b>	Black
<b>Output</b>	Blue

*No Cable Available*

**Connector Options**

Molex Mini-Fit Jr. (Male)

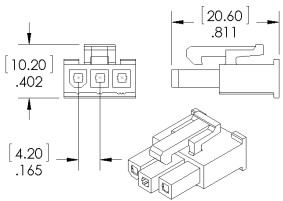

Molex Mini-Fit Jr. (Female)

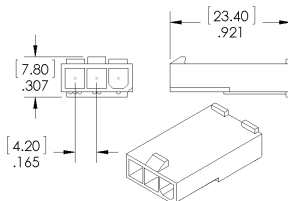

TE AmpModu MTE (Male)

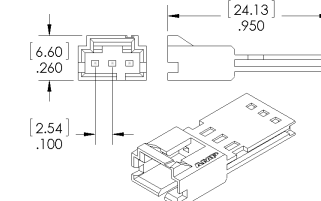

TE AmpModu MTE (Female)

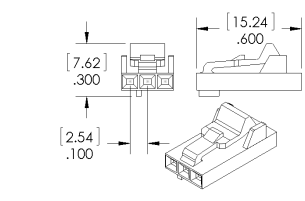

*Need a different connector? Contact [sales@phoenixamerica.com](mailto:sales@phoenixamerica.com).*

**Part Number Description**

<b>P5</b>	<b>C</b>	<b>F</b>	<b>B</b>	<b>X</b>
<b>Series</b>	<b>Output Type</b>	<b>Wiring</b>	<b>Length (Meters)</b>	<b>Connector</b>
P5	<b>C</b> Open Collector (default) <b>P</b> Open Collector with Internal Pull-Up (4.7K)	<b>F</b> Flying Leads (default)	<b>A</b> .5 (19.685") <b>B</b> 0.914 (36") (default) <b>C</b> 1 (39.370") <b>D</b> 2 (78.740")	<b>X</b> None (default) <b>A1</b> TE AmpModu MTE (Male) <b>A2</b> TE AmpModu MTE (Female) <b>M1</b> Molex Mini-Fit Jr. (Male) <b>M2</b> Molex Mini-Fit Jr. (Female)

Example: P5-C-F-B-X