

Features and Benefits

- Non-contact, solid state device
- Tight magnetic tolerance around zero Gauss level provides 50% duty cycle
- Reads speeds 0 to 100 kHz
- Digital output signal
- 4 to 24 VDC operation range
- Current sinking output
- 20 mA continuous operation
- Reverse polarity protection
- Temperature compensated
- Operates from -40°C to 125°C
- Rugged thermoplastic housing



Sensor

Electrical Circuit

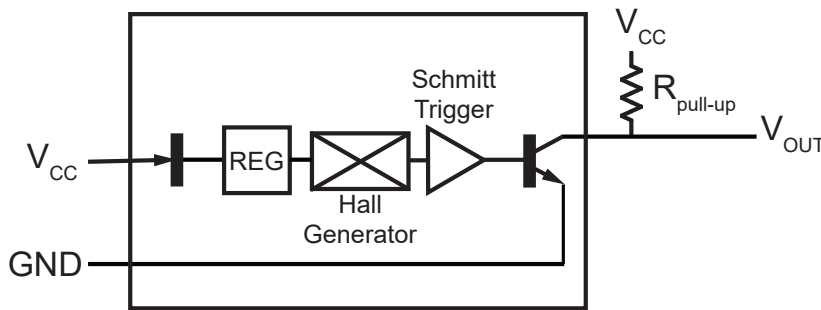

Output channels require customer supplied pull-up resistors unless internal pull-up option is selected. See Table 1.1 for recommended resistor values.

Note: A pull-up resistor is required on the open collector output to establish a quiescent voltage level. The pull-up resistor also provides faster rise times and improves noise immunity. Contact the factory for application assistance.

Pull-Up Resistance Chart for Selected Sink Currents

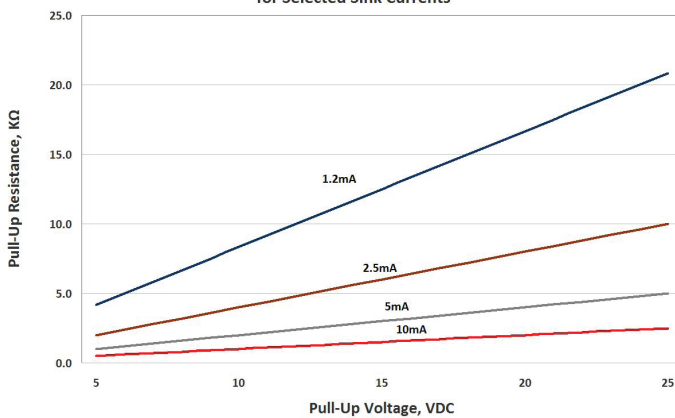

Table 1.1

Recommended Pull-Up Resistor Values			
Current, I _{sink}	Supply Voltage		
	5	12	24
1.2 mA	4.3K	10.0K	20.0K
2.5 mA	2.0K	4.7K	10.0K
5 mA	1.0K	2.4K	4.7K
10 mA	510Ω	1.2K	2.4K

I_{sink} is application dependent. It is recommended to use the lowest possible sink current when selecting a pull-up resistor.

Theoretical Pull-Up Resistor Calculation: $R_{pullup} = \frac{V_{supply}}{I_{sink}}$

Resistance values based on closest standard 5% resistor values

Absolute Maximum I_{sink} = 20mA

4.7 K pull-up is available as a standard option. If an alternative pull-up value is preferred, contact sales@phoenixamerica.com.

Physical Outline

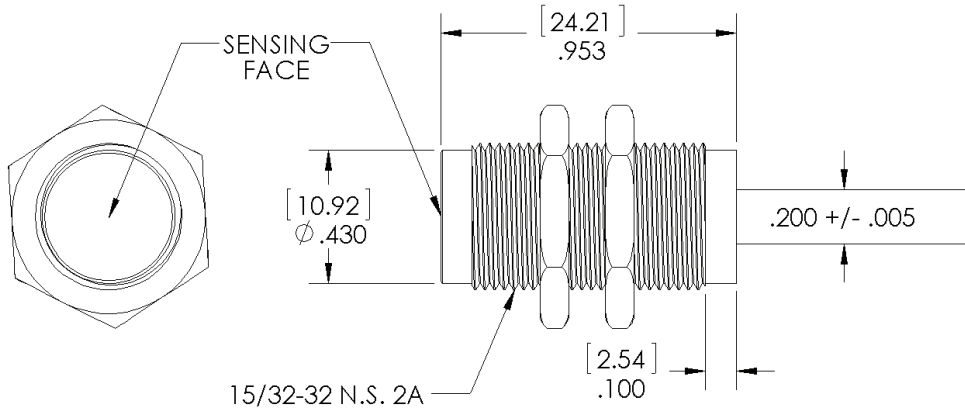

Output Waveforms

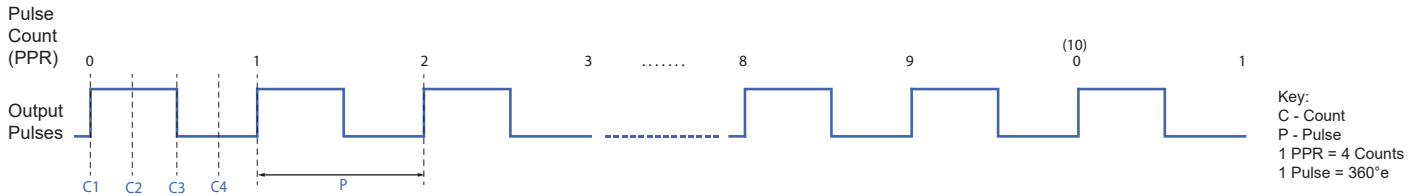

Magnetic Characteristics (VCC = 4.5 to 24 VDC @ 25°C)

Table 2.1

Characteristic	Symbol	Limits			
		Min.	Typ.	Max.	Units
Operating Point	B _{OP}	15	50	75	Gauss
Release Point	B _{RP}	-75	-50	-15	Gauss
Hysteresis	B _{HYS}	30	100	150	Gauss
Maximum Field Exposure	B _{MAX}	-800		800	Gauss
Active Element Depth	D _P			0.048	Inch

Electrical Characteristics (T = -40 to 125°C)

Table 2.2

Characteristic	Symbol	Test Condition	Limits			
			Min.	Typ.	Max.	Units
Supply Voltage	V _{CC}	Operating	4.5		24	VDC
Supply Current	I _S	V _{CC} = 4.5V; Output Open		4.7	8.0	mA
Output Current	I _{OUT}	V _{CC} = 4.5V; Output Open			20	mA
Output Saturation Voltage	V _{OUT(SAT)}	B > B _{OP} ; I _{OUT} = 20ma		150	400	mV
Output Leakage Current	I _{OFF}	B < B _{RP} ; V _{OUT} = 24V		4.7	8.0	µA
Rise/Fall Time	t _r / t _f	R _L = 1.2k; C _L < 33pF			1	µs

Wiring

FLYING LEADS

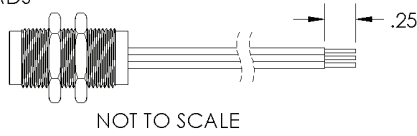

- 22 AWG
- PVC Insulation

CABLE

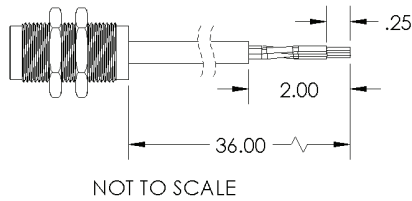

- 22 AWG
- PVC Insulation

Table 3.1

Standard Wiring Color Code		
	Flying Leads	Cable
Vcc	Red	Brown
Gnd	Black	Blue
Output	Blue	Black

Custom lengths and insulation materials available. Contact sales@phoenixamerica.com.

Connector Options

Molex Mini-Fit Jr. (Male)

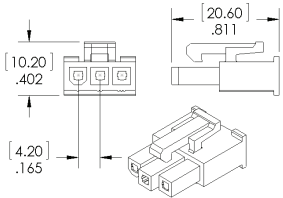

Molex Mini-Fit Jr. (Female)

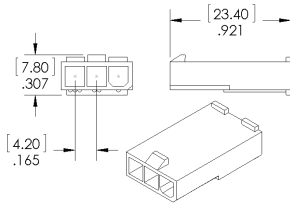

TE AmpModu MTE (Male)

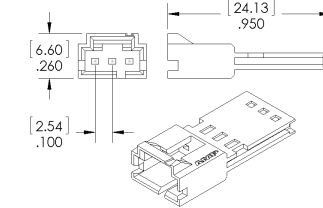

TE AmpModu MTE (Female)

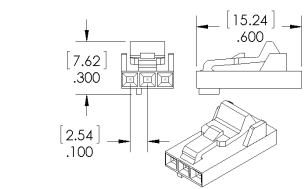

Need a different connector? Contact sales@phoenixamerica.com.

Part Number Description



Series	Output Type	Wiring	Length (Meters)	Connector
S1	C Open Collector (default) P Open Collector with Internal Pull-Up (4.7K)	F Flying Leads (default) C Cable	A .5 (19.685") B 0.914 (36") (default) C 1 (39.370") D 2 (78.740")	X None (default) A1 TE AmpModu MTE (Male) A2 TE AmpModu MTE (Female) M1 Molex Mini-Fit Jr. (Male) M2 Molex Mini-Fit Jr. (Female)

Example: S1-C-F-B-X